

VENTURA<sup>®</sup>  
LEGNOKLAD **DUO**

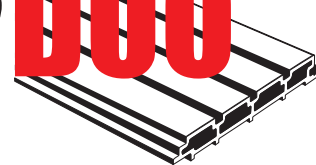

*new*  
**The Bold & Elegant Facades**

# VENTURA<sup>®</sup> LEGNOKLAD DUO



India's First and Only  
**DUAL FINISH**  
**WOOD & BLACK**  
Exterior Cladding



Water  
Proof



Termite  
Resistant

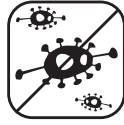

Fungus  
Resistant



Impact  
Resistant

With SYNCHRO  
REAL WOOD  
EMBOSSING  
MORE THAN  
1MM IN DEPTH



Eco  
Friendly



Long  
Lasting



Weather  
Friendly



Low  
Maintenance



Scratch  
Resistant

## INSTALLATION INSTRUCTIONS

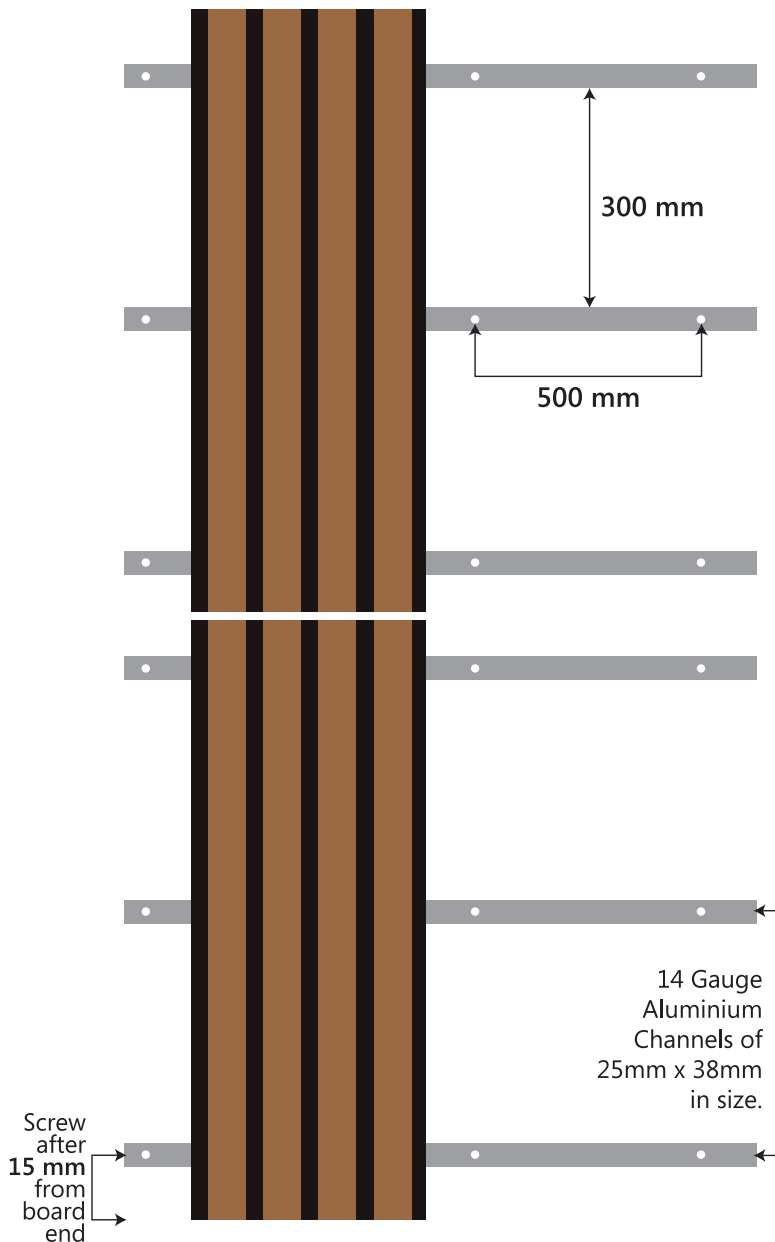

1. Fix the Aluminium Channels at a 300 mm interval to the wall with expansion screws. The spacing between two adjacent screws should be 500 mm.

2. Double Aluminium Channels are needed at the end-to-end joint between two cladding boards to ensure that each board is supported by Aluminium Channel.

3. Leave an expansion gap of about 8 mm between the ends of two cladding boards to avoid the risk of cracking and warping.

4. Always pre-drill pilot holes before driving screws to avoid damage to the cladding board.

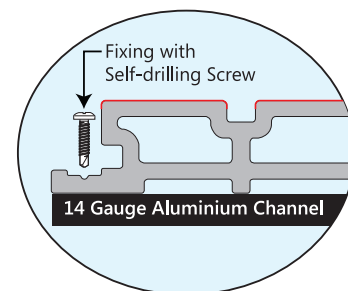

**IMPORTANT :** VENTURA LegnoKlad DUO should always be stored horizontally  
• Powder coated End Profile as per requirement • Installation should go from bottom to top

# VENTURA®

## LEGNOKLAD DUO

### COLOUR OPTIONS



DUO Birch New

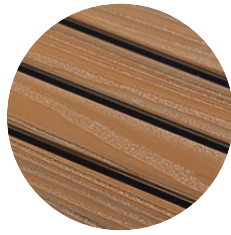

DUO Teak

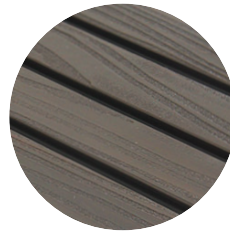

DUO Walnut

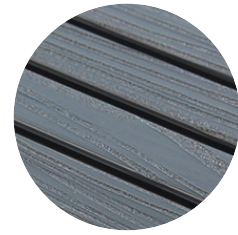

DUO Stone Grey



### TECHNICAL INFORMATION

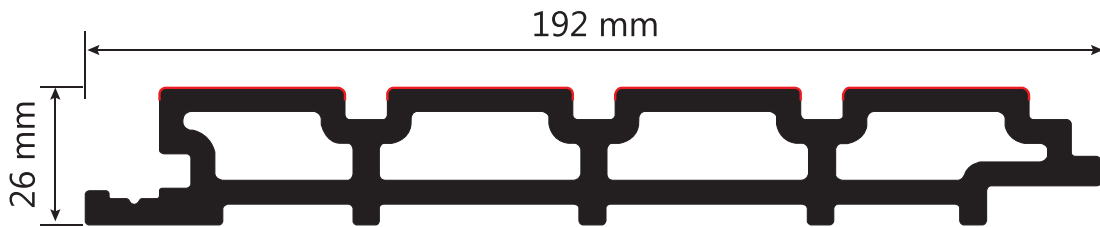

Length : 2900 mm (9' 6")  
Width : 192 mm (7.6")

Thickness : 26 mm (1.3")  
Density : 1.33 gms/cm<sup>3</sup>

No. of waves per board : 4  
Depth of waves : 6 mm

### FEATURES AND ADVANTAGES

- STUNNING CONTRAST OF DUAL WOOD & BLACK FINISHES
- HIGH GRADE POLYMER SURFACE COATING
- MULTI-CHROMATIC COLOURS
- MODERN OPEN-JOINT APPEARANCE
- LOAD BEARING CAPACITY WITH SUPERIOR LONG SERVICE LIFE
- HIGHLY RESISTANT TO MILDEW, SCRATCH, SPLINTERING AND MOISTURE
- 100% RESISTANT TO TERMITES
- QUICK & EASY TO INSTALL
- REAL WOOD LIKE LOOK AND FEEL
- HOLLOW PROFILE, HIGH STRENGTH
- EXCEPTIONALLY ADAPTABLE TO VARIOUS WEATHER CONDITIONS

### Matching Colour END PROFILE

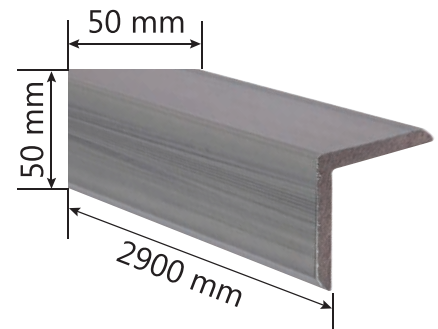

Length : 2900 mm  
Width : 50 mm  
Height : 50 mm

Material Composition :  
**Made of 50% Wood Fiber, 38% HDPE, 12% Additives**

Certificates :  
**FSC, CE, CNAS, ISO 9001:2019**



\* Scan this QR code for Warranty Terms & Conditions





**VENTURA**  
Since 1994



**Ventura International Pvt. Ltd.**  
Office • Architectural Experience Centre

1/120, W.H.S., Kirti Nagar, New Delhi-110015  
Phone: 91-11-4554 6700 (100 Lines)  
E-mail: [mktg@venturaindia.com](mailto:mktg@venturaindia.com)  
Website: [www.venturaindia.com](http://www.venturaindia.com)



[f/venturaintl](https://www.facebook.com/venturaintl)  
[yt/user/venturaindia](https://www.youtube.com/user/venturaindia)  
[in/Venturaintl](https://www.linkedin.com/company/Venturaintl)  
[@Venturaintl](https://www.instagram.com/Venturaintl)

