



VENTURA
Premium Architectural Surfaces
Since 1994



3d wall
Panel Systems
TURKEY

A GEOMETRICAL **WONDER**

3d wall

Display in various locations across India.

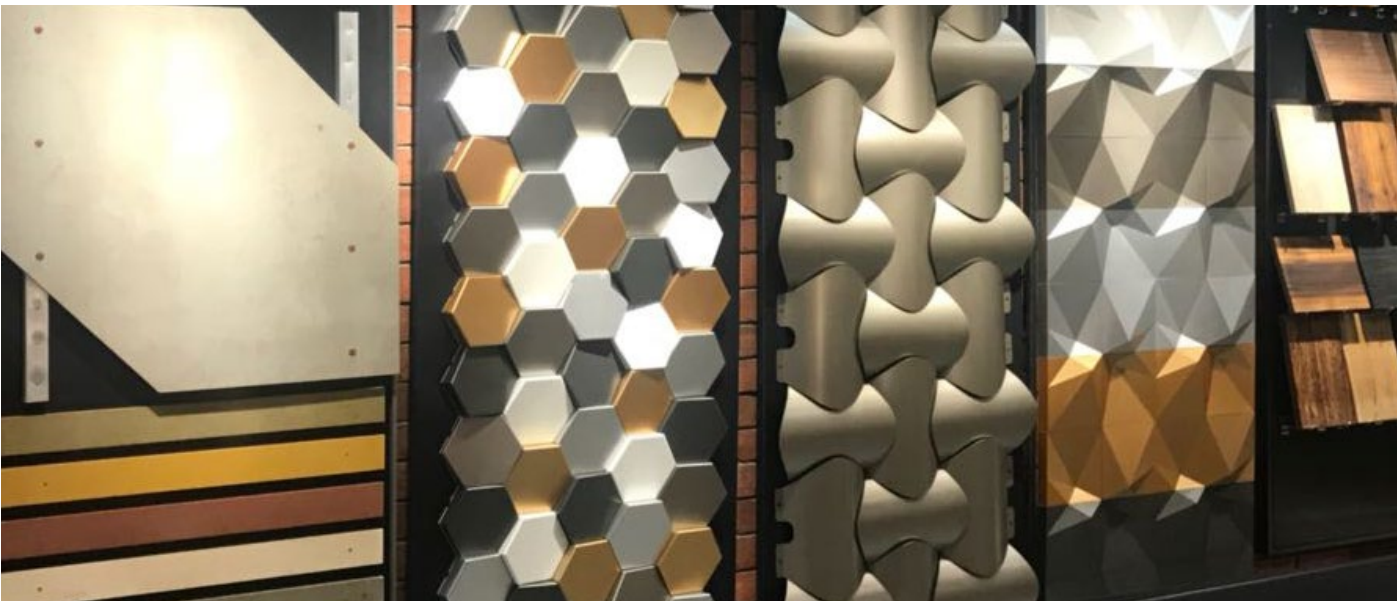

Interior Wine Room

Ventura International Pvt. Ltd. was conceived in 1994, under the leadership and guidance of young and energetic entrepreneurs who transferred their spirit into the company's wiring ethos. They soon identified the gap in creative needs of interior designers and architects and with that of the materials available in the market, and pledged to fill that with the best the world can offer. Ventura is today one of the leading Importer in an exclusive range of premium interior decorative architectural and interior related products.

The company has an employee strength of more than 30 in their corporate headquarters in Delhi, assisted by 10 sales personnel stationed across the country. The sales network includes more than 100 distributors having sales points in prime locations in all the major cities of India. The marketing network includes direct, and intensive contact with more than 2000 leading Architects & Interior Designers across India.

Ventura's Mission is to satisfy maximum creative needs of the Interior Designers, Architects and Furniture manufacturers in India. It believes in offering the best possible products sourced across the globe which matches the taste and need of every individual.

Ventura is an exclusive Importer and remitter for a range of Metallic Laminates, Hand Made Designer Laminates, Architectural Facade Panels, Woodbased Solid Surface Panels, Embossed Architectural Panels, Faux Leather Tiles and Panels, Self-Adhesive Wooden Wall Panels, Decorative Premium Veneers and many more path breaking products.

These premium architectural surfaces are imported from Germany, Italy, Turkey, USA, United Kingdom, Korea and Portugal. The products are Cosigned for providing the customers with the latest international blend of design and lifestyle.

These architectural wines are suitable for a host of application areas including showroom displays, residences, office interiors, multiplexes, outdoor and indoor facades etc.

We now proudly present our innovative interior paneling product – 3D Wall Panels, a futuristic and geometric modular tile system from Turkey. These tiles come in 4 modern shapes and variants, in several colors. The whole system is very dynamic and flexible in terms of installation and appearance. We have showcased this product in the following pages, and hope it finds a place in the designer's interior concept.

THE GENESIS



NORM

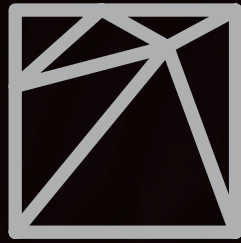

PENTA



SPLINE



MABEL

Each of the products from the **3D Wall Panel Systems** collection has its own unique shape. These specific shapes have been derived from the form and structure of the respective product, for **Norm** the hexagonal shape, **Penta** the pentagonal surface, **Spline** the splay lines and **Mabel** the polygonal geometry.

These simplified shapes have been used as a motif to form patterns and have been used in the brochure as inside page elements. For the cover, the derived patterns have been clubbed together to form a uniform pattern which consists all of the four products.

HENCE, THE TAG NAME OF A GEOMETRICAL WONDER

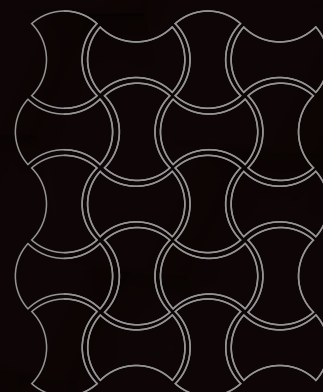
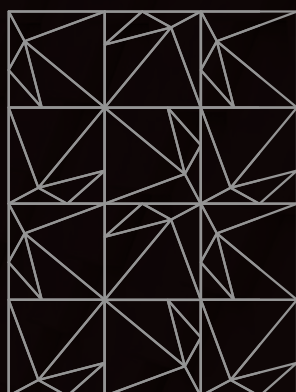
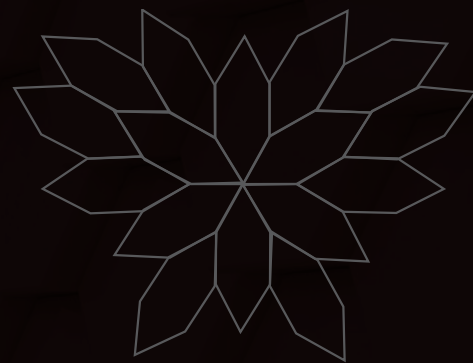

A RĒVOLUTION

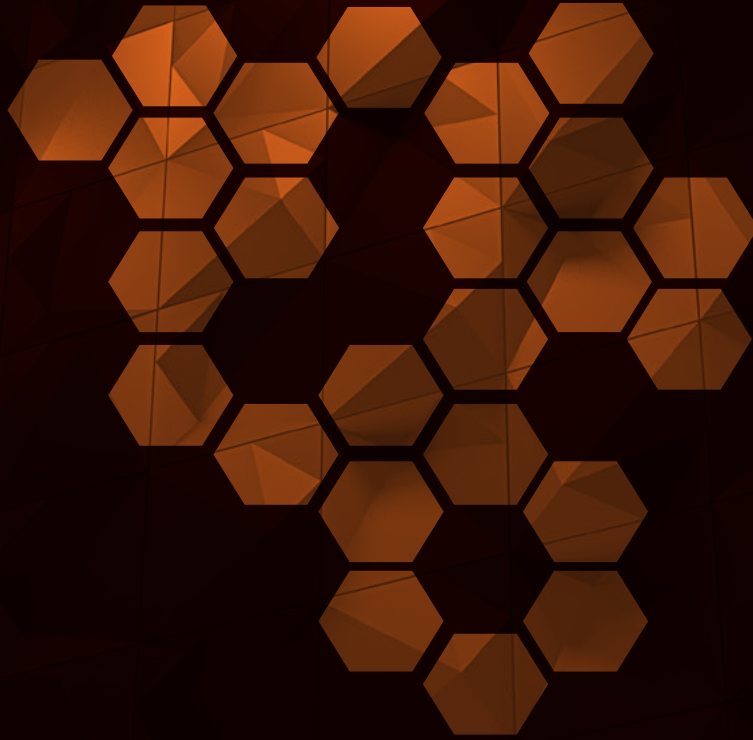

We present the most innovative trend of the decade-**3D Wall Panel Systems** from the House of European designers who have brought a revolution in the world of Architecture and Interiors. These trendy and futuristic tiles are made from high tech special polymer and can have glazed and matte finishes, basis your interior vision. Widely used in both commercial and residential interiors, the tiles and panels come with easy push button system for installation. So now add rich textures to your spaces with our creative, visionary solutions for your places!

3dwall
NORM

THE
NORM
SERIES



Norm Anthracite & Silver Lounge, Private Residence, Istanbul

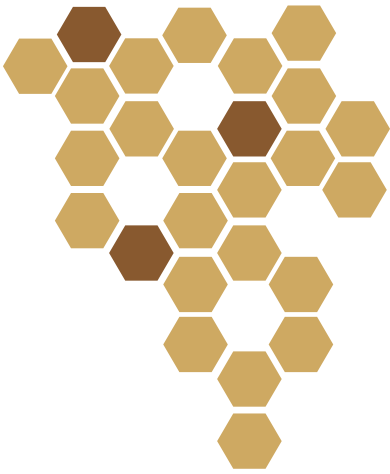

— CREATING INNOVATIVE SPACES

Design with ability to create infinite concept, the Norm is a small hexagonal tile pivoted at various angles to create different shades, imagery and graphics. The functional patterns created by the tiles are visually empowering and gives any interior a unique design intent.



Norm White Children's Room, Private Residence, Munich

3d wall
NORM

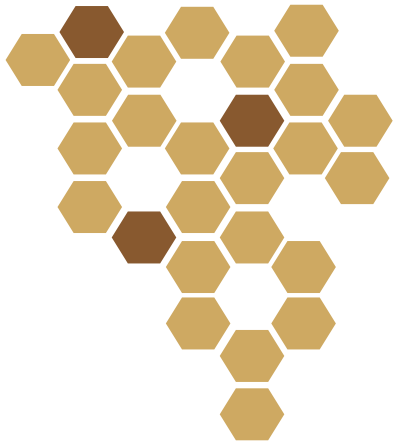

STYLE AS A WAY OF LIFE



Norm Gold, Silver, White, Anthracite, Corporate Office, Passage, Milan

Available Colors



Gold



Silver

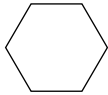

White
Glossy



Anthracite



Smoke

The Norm series is as easy to install, as the Lego System and can be used to create more than 150 types of imagery. Various colours, different types of surface finish and flexible ways of application makes Norm one of the most preferred dimensional decor partner for designers across the globe.



EXPERIENCE GRANDEUR



Norm White, Bedroom Private Residence, New York



Norm White, IT Office, Bengaluru

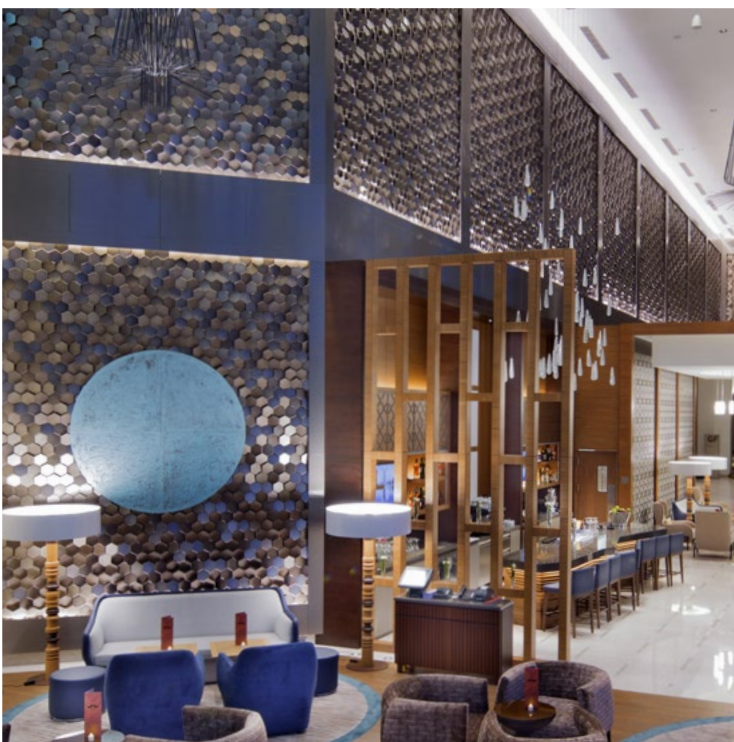

Norm, Gold, Silver, Anthracite, Hotel Lobby, Dubai



Norm Gold, Silver, Smoke, White, Anthracite
Hotel restaurant, Brussel

3d wall
PENTA

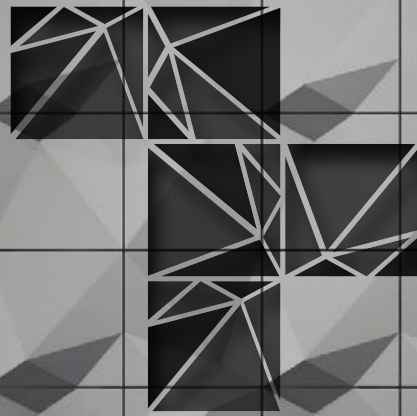

THE
PENTA
SERIES



ADD RICHNESS TO YOUR DECOR

Meet the future of design, **Penta** panels which are designed using irregular concave and convex lines at different angles on the plane, using this five sided tile. For those who love **exclusivity**, the Penta panels provide a sense of depth to the wall by playing with light spectrum in a way that it adds to the richness of the room decor in the most unique way.



IRREGULAR SYMMETRY



The Penta series is a class an eye catching 3D wall panel system, which creates fascinating multitude reflections resembling natural sceneries. Easy to apply, different surface finishes and various colours in the panels host a variety of interesting decor options for those who love everything Bespoke.

THE FUTURE IS HERE

Available Colors



Gold



Silver



White
Glossy



Anthracite



Smoke



Penta Anthracite, Living Room, Private Residence, New Delhi



Penta Silver, Corporate Office, Baroda

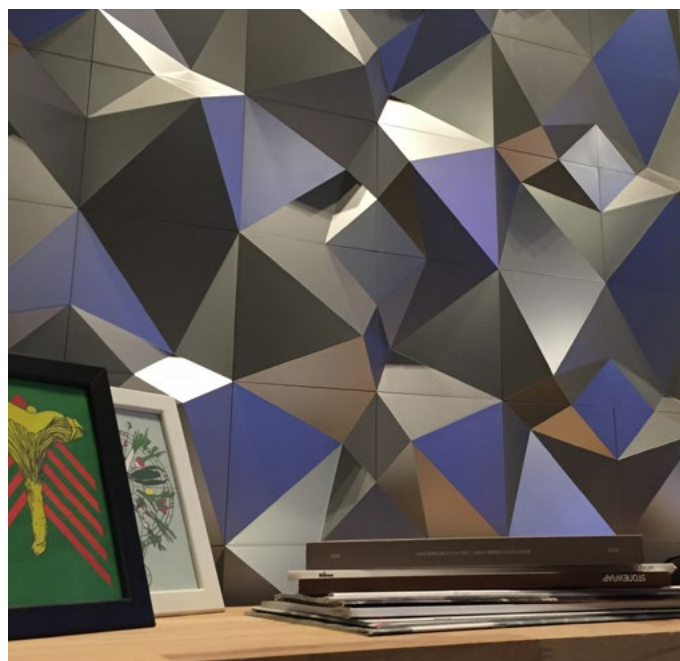

Penta Anthracite, Private Bedroom, Singapore

3d wall
SPLINE

THE SPLINE SERIES



STRIVING FOR AESTHETIC BEAUTY

Thought provoking and artistic, the Spline panels are visually inspired by moving splay lines. These panels have their own certificate of design and are comprehensive in terms of colours and surface finishes. The panels can be used for interior walls and ceilings to get you the surfaces you adore.



3d wall
SPLINE

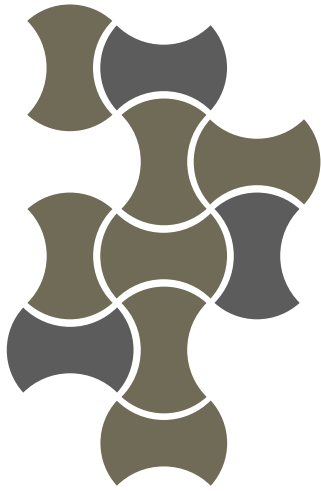

GIVE CHARACTER TO YOUR WALL



Spline Silver, Restaurant, Dubai

The Spline series is strong, durable and light and is made up of high grade polymers. These innovative panel systems can be combined and arranged according to your interior needs creating unique spellbinding effects.



Spline Gold, Smoke
Corporate Office Mural, New Delhi

MAKE A GRAND ENTRANCE



Spline Gold, Boutique, Los Angeles

Available Colors



Gold



Silver



White
Glossy



Anthracite

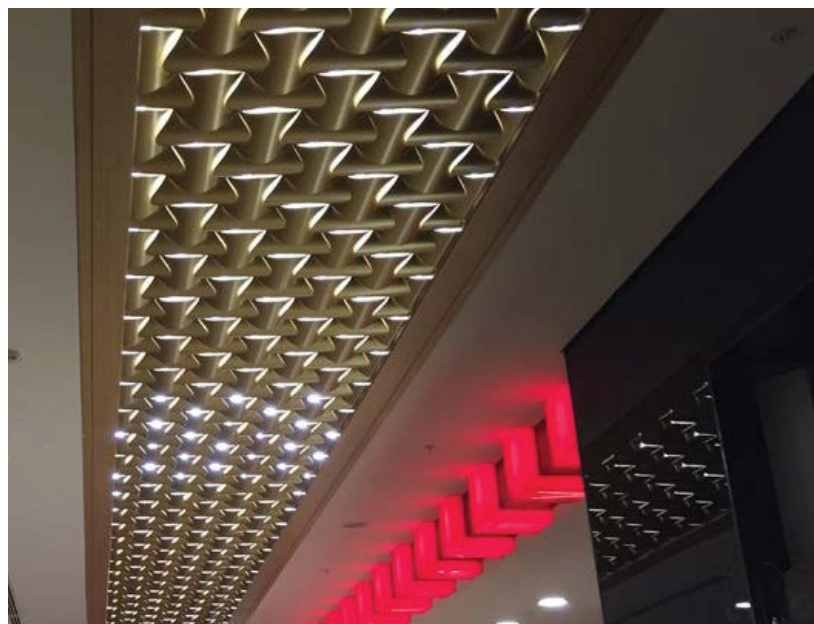

Spline Gold, Cinema Theatre, Mumbai

3d wall
MABEL



M A B E L
S E R I E S

— INNOVATIVE PANEL CONCEPT FOR TODAY'S ARCHITECTURE



These small polygonal tiles when laid in opposing directions create a subtle geometric stripe. Design of the tile give a sense of depth to the Wall by playing with the lights and shadows created by Mabel's polygonal geometry. This surface-based experimental design approach to a wide variety of contexts and applications in interior design. Shape of the tile creates an illusion of colour shades through the natural reflection of lights.



INDEPENDENT MOVES

A contemporary tile Mabel takes its roots from flower petals which when laid on wide spaces in a great harmony and rhythm appear beautifully symmetrical. We combined cultural heritage of nature with architecture while designing 'Mabel'.

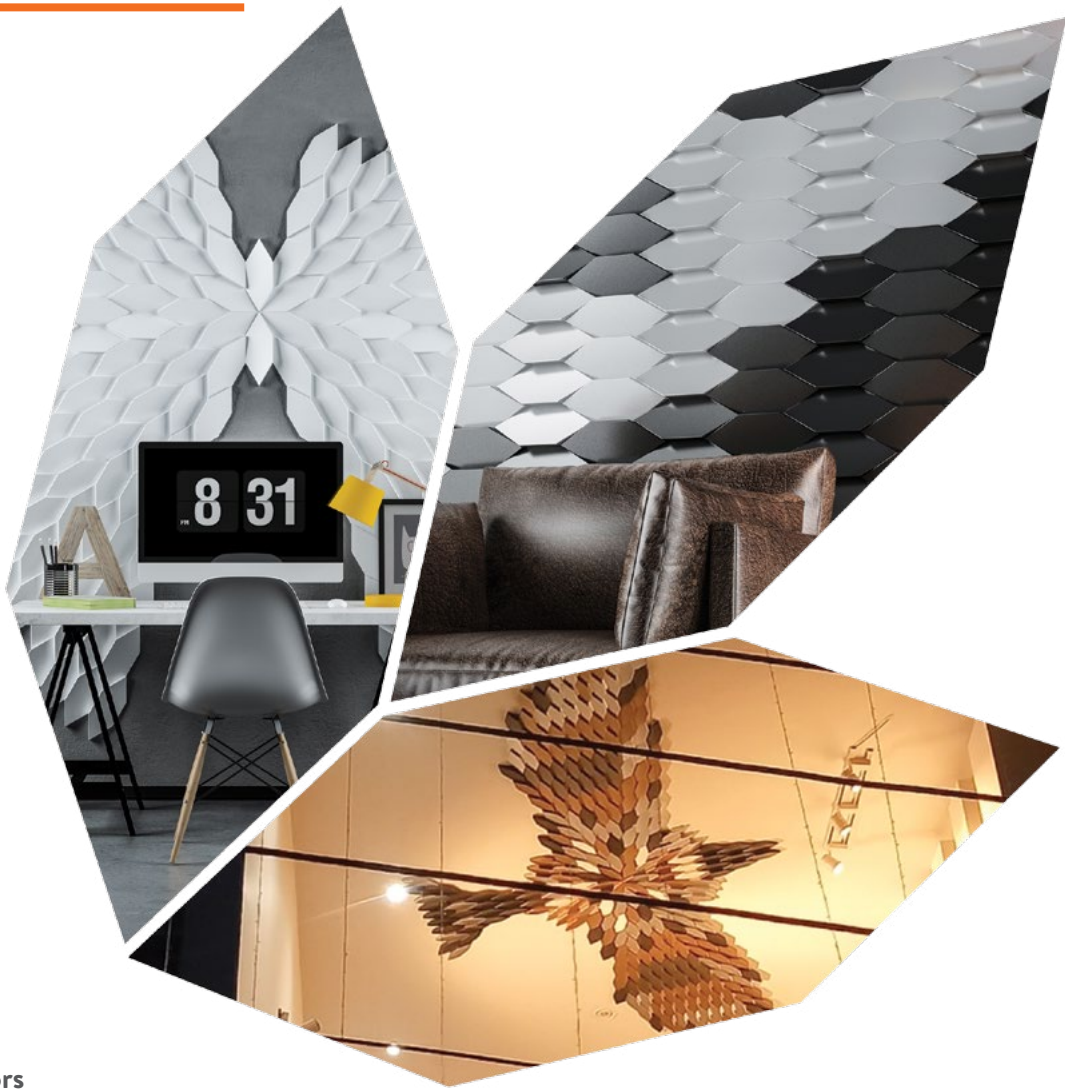

Available Colors



Gold



Silver



White
Glossy



Cold Grey



Smoke



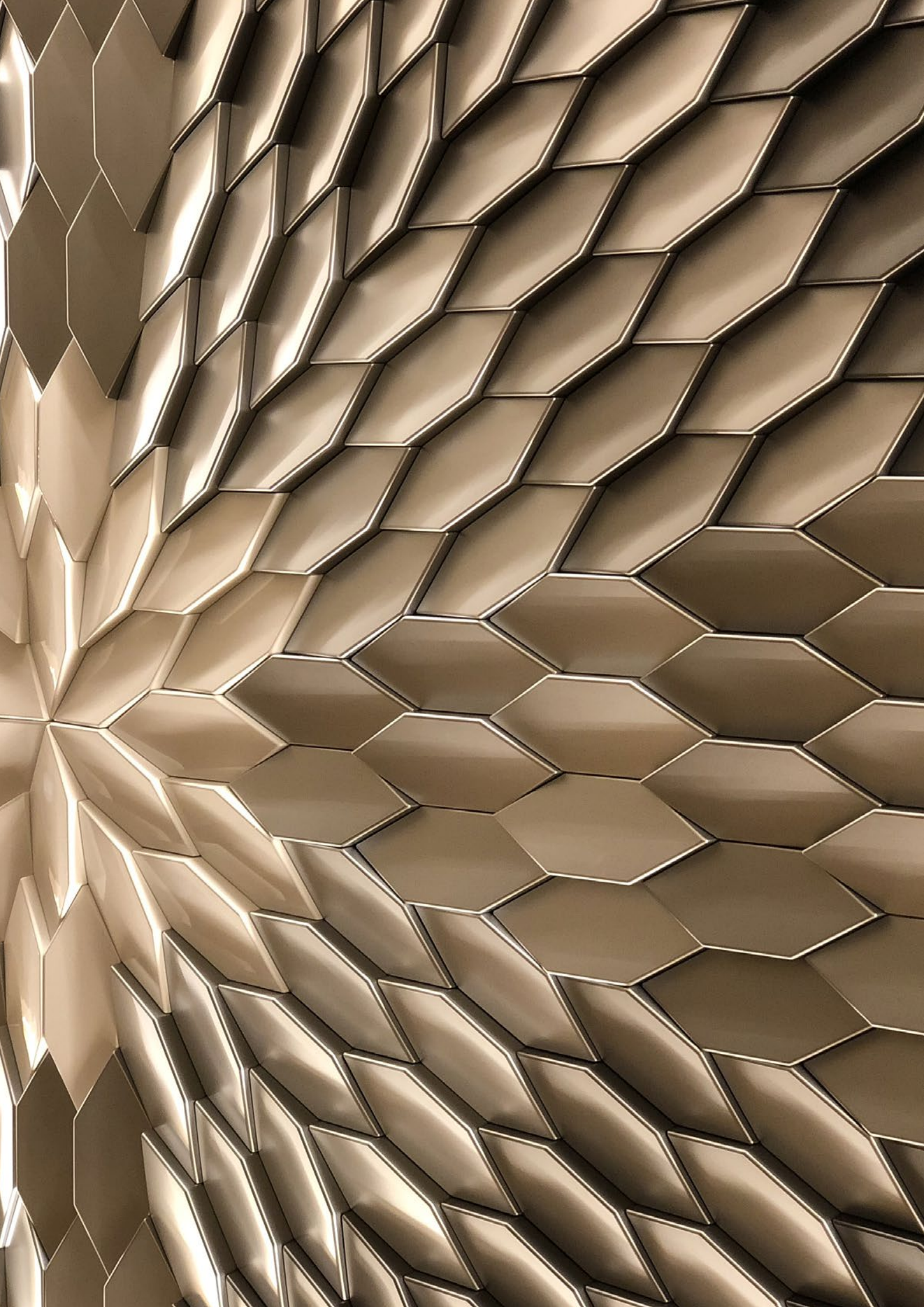

3d wall ZETA

3d wall ZETA is the latest introduction in 3d wall panel product range. Hexagonal tiles consist of a modular tile designed using irregular concave & convex lines at different highs and angles on the plan. The different highs and angles give a sense of depths to the wall by playing with the lights and shadows.

AVAILABLE COLOURS:



JET BLACK



ANTHRACITE



GOLD



SILVER



WHITE GLOSSY

TILE DIMENSIONS

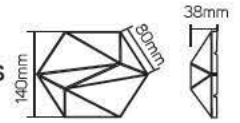

3d wall Zeta - White

Private residence, Spain



3d wall Zeta - Silver
Reception Area wall, Travel Company, Germany



3d wall Zeta - Jet Black
Private Residence, Germany



3d wall Zeta - White
Private residence, London

INSTALLATION INSTRUCTIONS

NORM

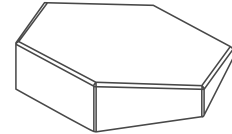

The upper visual part of the fitting is installed on the lower installation part which serves as a frame and has screwing and centering holes. The two parts can be centered to each other easily, by fixing the pin holes of upper visual part to the jags on the lower installation part. The installation method is very simple like the LEGO push button system.

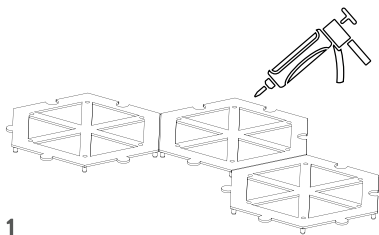
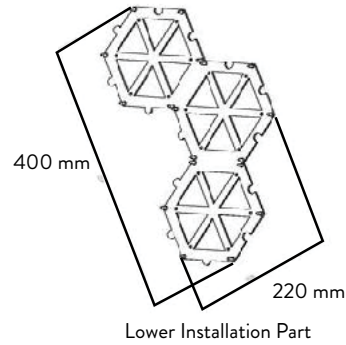
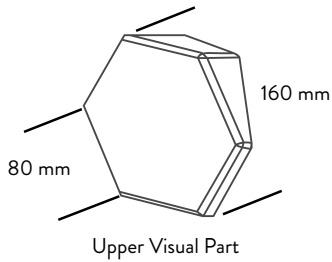

1

- ▶ Start the pasting process by applying silicone behind the bottom apparatus.

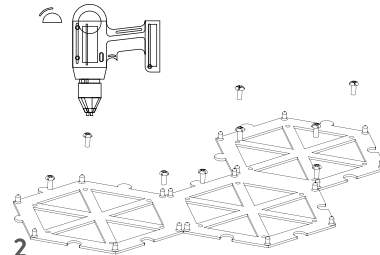

2

- ▶ Once the pasting process is over, strengthen the apparatus by screwing it from determined points.

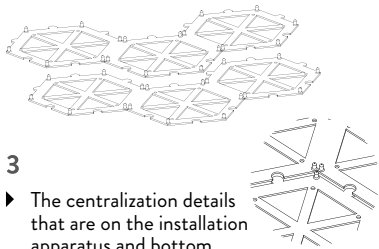

3

- ▶ The centralization details that are on the installation apparatus and bottom apparatus are attached to each other.

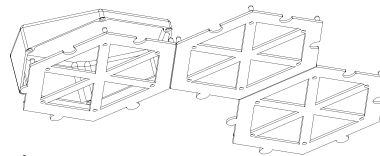

4

- ▶ Complete the installation process by attaching the pin space holes that are on the side of the top parts of the product to the pin bulges that are on the bottom installation apparatus.

PENTA

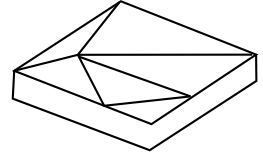

The upper visual part is installed on the lower part which serves as a frame and has screwing and centering holes. The two parts can be centered to each other easily, by fixing the pin holes of upper visual part to the jags on the lower installation part.

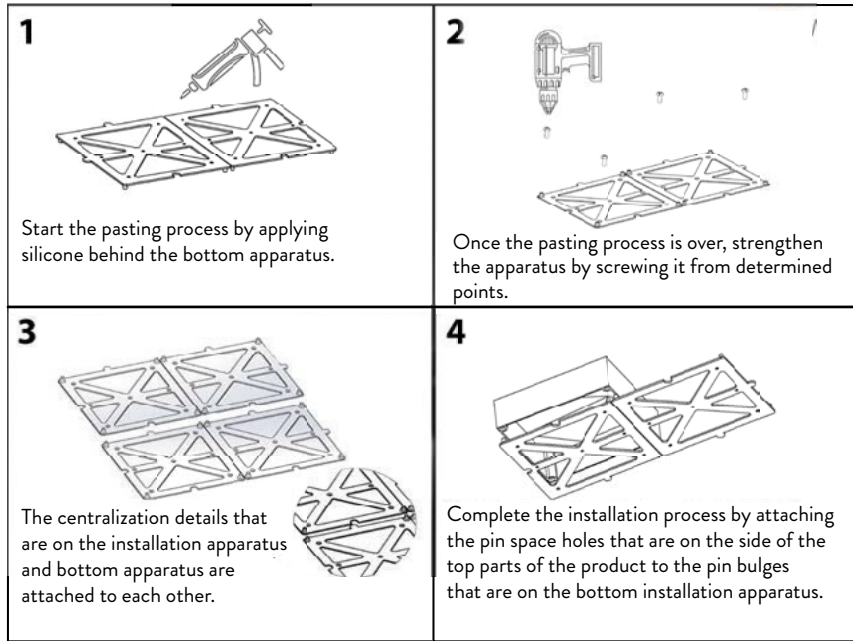

SPLINE

Spline is modular system which can be extended in any direction and custom sizes to suit any spaces.

Product installation model shown as follows :

- 1 Oval Product Surface
- 1.1 Lightning (LED) Canal
- 1.2 Assembly Part
- 1.3 Assembly Screw Hole
- 2 Screw

Spline panels can be made even more dynamic and alive by installing LED light strips behind them.

There is no need to install any framework before product installation. Just screw the product on a wall.

Wall surface must be Gypsum/MDF/Wood-Based Surface.

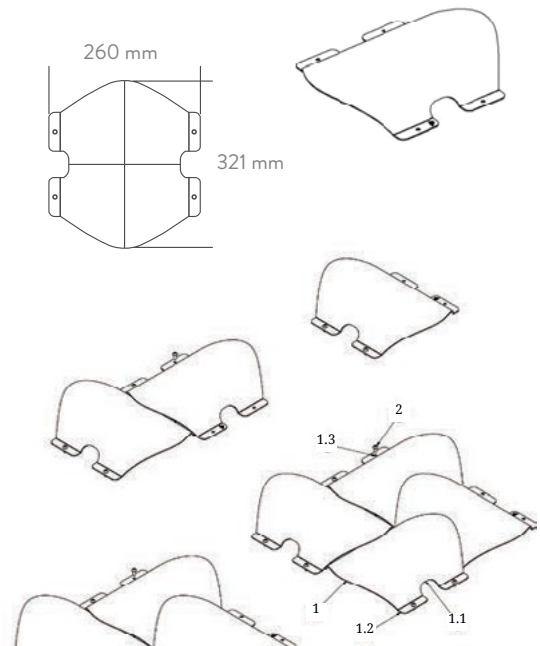

MABEL

The upper visual part is installed on the lower part which serves as a frame and has screwing and centering holes. The two parts can be centered to each other easily, by fixing the pin holes of upper visual part to the jags on the lower installation part.

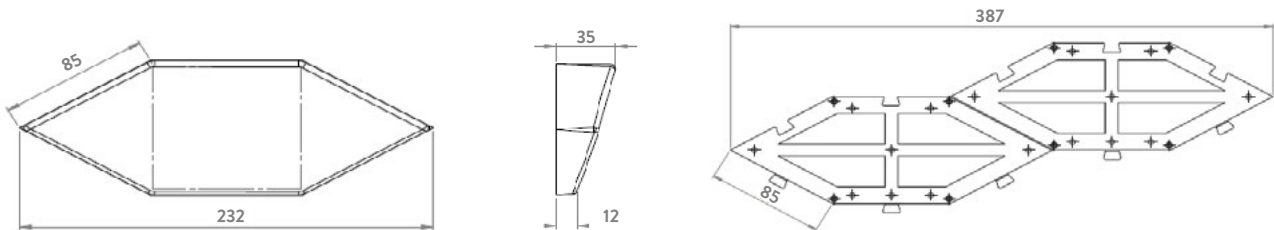

TECHNICAL DATA :

SPECIFICATION		NORM	PENTA	SPLINE	MABEL
THICKNESS AND SIZE		2 mm/Regular Hexagon 80 mm side	2 mm / 180 X 180 mm	2.50 mm / 321 X 260 mm	2 mm / Irregular Hexagon 85 mm
DIMENSIONS		Lowest Point 10 mm Highest Point 45 mm	Lowest Point 42.5 mm Highest Point 72.5 mm	Highest Point 62.5 mm	Lowest Point 12 mm Highest Point 35 mm
WEIGHT		90 gms/pc 4.860 kg/m ²	170 gms/pc 5.100 kg/m ²	200 gms/pc 4.800 kg/m ²	88 gms/pc 6.16 kg/m ²
FINISHES AVAILABLE		Matt / Gloss			
MATERIAL		Strong, Light and Strong Copolymer			
APPLICATIONS		Interior/Exterior use for walls and ceilings			
PACKAGING					
Pcs/Box	Upper Part box	54	30	24	
	Installation Part box	36	30		
Kg/Box	Upper Part box	5.50 kg	5.10 kg	5.50 kg	
	Installation Part box	2.60 kg	2.60 kg		
Sqm/Box		1 sq mtr			



Flammability
UL 94 / V-0



Surface Quality
A1



Flexural Strength
ISO178 / 63MPa



Size Accuracy
+/-0.5%



Temperature
Resistance

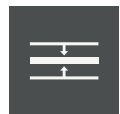

Thickness
Accuracy
+/-0.5%

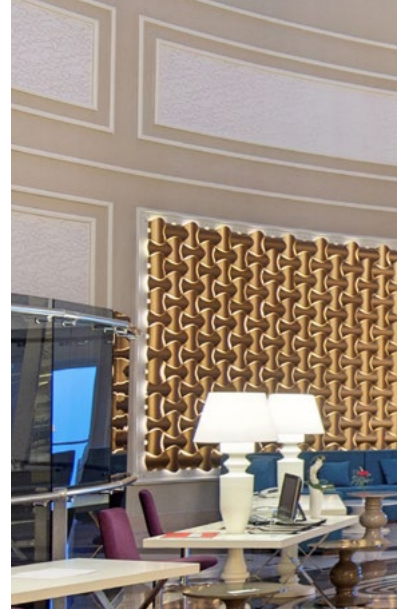

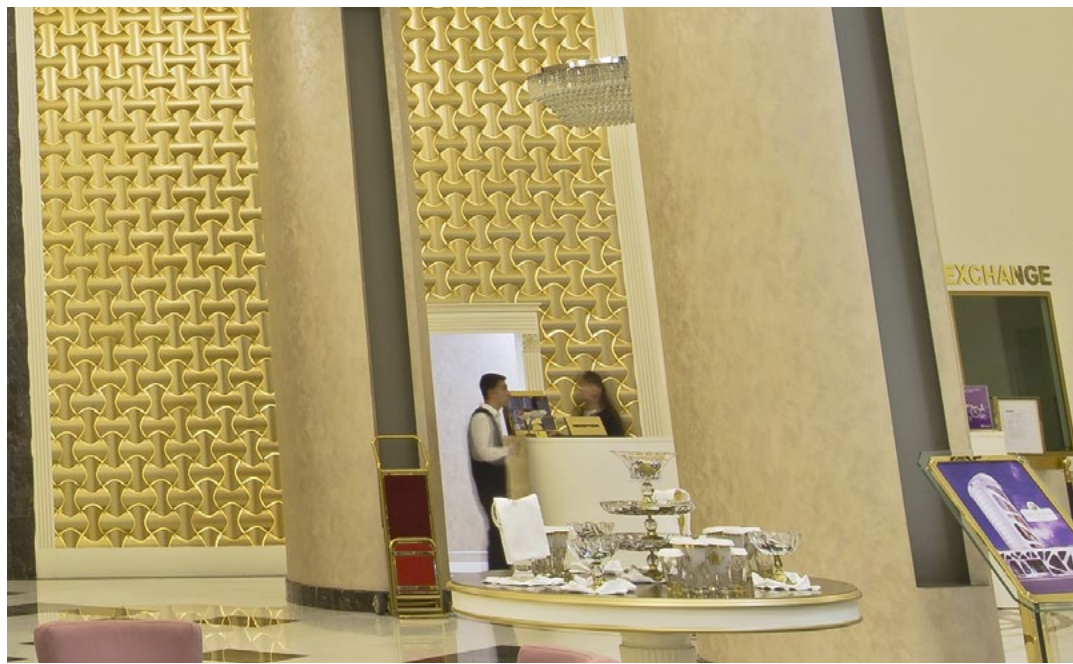



3d wall

Panel Systems
TURKEY

Ventura brings to you the world's first 3 dimensional modular panel system based on high strength polymers, and with designer geometrical contours. These 3D Wall Panels Systems can transform ordinary interiors to spectacular and dramatic spaces. A revolution in the world of interior design, now in India.



Ventura International Pvt. Ltd.
Office - Architectural Experience Centre
1/120, W.H.S. Kirti Nagar
New Delhi - 110015, India
Phone : 91-11-4554 6700
Toll Free : 1800 103 6756
www.venturaindia.com

